

### F-142XP

#### Electrical Specifications (@25C)

1. Maximum Power: 4.5 VA
2. Primary: 115V 50/60 Hz
3. Secondary: Series: 15.0V CT @ 0.300 Amps  
Parallel: 7.5V CT @ 0.600 Amps

#### Description:

The F-142XP is part of a wide selection of plug-in types that meet the needs of PC boards and solid state power supply design. This transformer can satisfy power as well as control and instrumentation applications.

#### Construction:

Wound on a single channel nylon bobbin. Materials are UL recognized, Class B (130° C) rated.

#### Safety:

These products are 100% hipot tested with an insulation of 1500V between primary and secondary windings.

#### Dimensions:

Units: In inches

A	B	C	D	E	F
1.437	2.375	1.250	2.00	0.406	1.093

Mounting hole: 0.187 in.

Pin length: 0.187 in.

Pin size: 0.20 x .041 in.

Weight: 7.5 oz

#### Schematic:

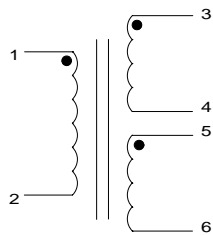

Primary: 1 to 2  
 Secondary: Series - 3 to 6, Jumper 4 to 5  
 Parallel - 3 to 5, Jumper 3 to 5 and 4 to 6

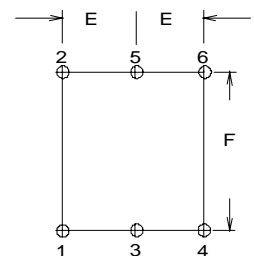
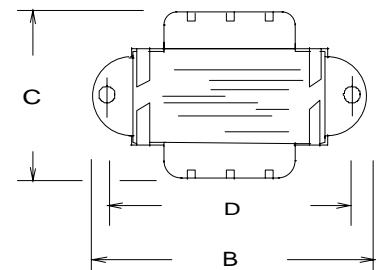
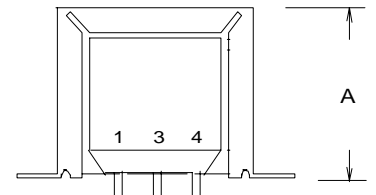

**RoHS Compliance:** As of manufacturing date February 2005, all standard products meet the requirements of 2002/95/EC, known as the RoHS initiative.

# Power Transformers

## PC Mount

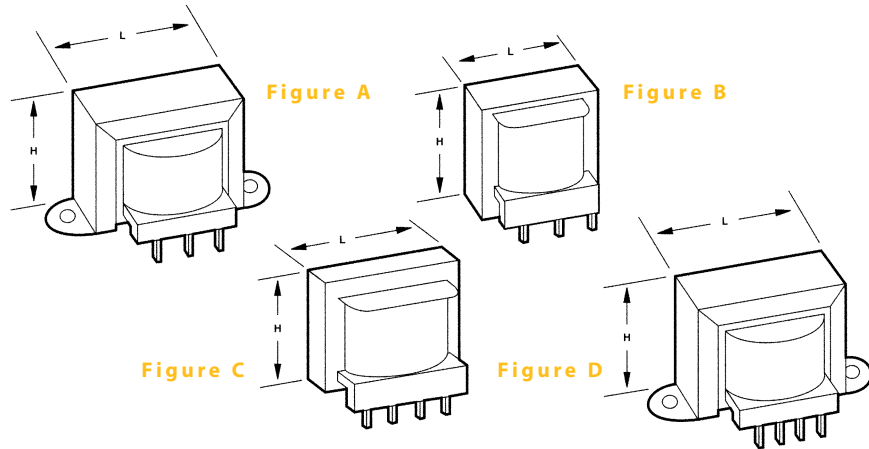

### :: Description

Triad power transformers are offered in a wide selection of plug-in types to meet the needs of PC board and solid state power supply designs. These transformers can satisfy power as well as control and instrumentation applications. The transformers are available in single or dual primary and dual center tapped secondary configurations.

### :: Specifications

Primary: 115 V, 50/60 Hz

### :: Single Primary, Dual Secondaries

Section	Type No.	Figure	VA	Secondary		Dimensions						Wt. Oz.	
				Series	Parallel	H	W	D	L	A	B		MW
A	F-131P	B	1½	8.0V CT @ 0.188A	4.0V @ 0.376A	1⅜	•	1½	1⅝	⅝	1	•	3.5
	F-139P			12.6V CT @ 0.12A	6.3V @ 0.24A								
	F-132P			15.0V CT @ 0.100A	7.5V @ 0.200A								
	F-150P			17.0V CT @ 0.085A	8.5V @ 0.170A								
	F-138P			25.2V CT @ 0.06A	12.6V @ 0.12A								
	F-133P			30.0V CT @ 0.050A	15.0V @ 0.100A								
	F-160P			34.0V CT @ 0.045A	17.0V @ 0.090A								
	F-137P			40.0V CT @ 0.038A	20.0V @ 0.076A								
	F-134P			54.0V CT @ 0.028A	27.0V @ 0.056A								
	F-135P			76.0V CT @ 0.020A	38.0V @ 0.040A								
	F-136P			116.0V CT @ 0.013A	58.0V @ 0.026A								
	B			F-141XP	A								
F-149XP		12.6V CT @ 0.35A	6.3V @ 0.70A										
F-142XP		15.0V CT @ 0.300A	7.5V @ 0.600A										
F-161XP		17.0V CT @ 0.264A	8.5V @ 0.528A										
F-148XP		25.2V CT @ 0.178A	12.6V @ 0.356A										
F-143XP		30.0V CT @ 0.150A	15.0V @ 0.300A										
F-162XP		34.0V CT @ 0.132A	17.0V @ 0.264A										
F-147XP		40.0V CT @ 0.112A	20.0V @ 0.224A										
F-144XP		54.0V CT @ 0.084A	27.0V @ 0.168A										
F-145XP		76.0V CT @ 0.060A	38.0V @ 0.120A										
F-146XP		116.0V CT @ 0.033A	58.0V @ 0.066A										
C		F-151XP	A	7½		8.0V CT @ 0.940A	4.0V @ 1.88A	1⅝	2⅝	1⅝	1⅝	⅝	1⅝
	F-159XP	12.6V CT @ 0.60A			6.3V @ 1.2A								
	F-152XP	15.0V CT @ 0.500A			7.5V @ 1.000A								
	F-163XP	17.0V CT @ 0.441A			8.5V @ 0.882A								
	F-158XP	25.2V CT @ 0.30A			12.6V @ 0.60A								
	F-153XP	30.0V CT @ 0.250A			15.0V @ 0.500A								
	F-164XP	34.0V CT @ 0.220A			17.0V @ 0.440A								
	F-157XP	40.0V CT @ 0.188A			20.0V @ 0.376A								
	F-154XP	54.0V CT @ 0.140A			27.0V @ 0.280A								
	F-155XP	76.0V CT @ 0.100A			38.0V @ 0.200A								
	F-156XP	116.0V CT @ 0.085A			58.0V @ 0.130A								

CT = Center Tap Mounting hole size: Figure A = ⅜"

### :: 115 Volts, 50/60 Hz Primary/Triple Output Secondaries for ±15 VDC and +5 VDC

Section	Type No.	Figure	VA	Secondary		Dimensions						Wt. Oz.	
				Secondary No. 1	Secondary No. 2	H	W	D	L	A	B		MW
D	F-165P F-167P	C	1½	24.0V CT @ 0.025A 32.0V CT @ 0.020A	9.0VCT @ 0.100A 15.0V CT @ 0.060A	1⅜	1⅝	1½	1⅝	⅝	1	•	3.5
E	F-168XP	D	4½	32.0V CT @ 0.050A	15.0V CT @ 0.195A	1⅜	2⅜	1¼	1⅝	¼	1⅝	2	7.5
F	F-166XP F-169XP	D	7½	24.0V CT @ 0.125A 32.0V CT @ 0.100A	9.0V CT @ 0.500A 15.0V CT @ 0.287A	1⅝	2⅝	1⅝	1⅝	¼	1⅝	2⅝	10.5

CT = Center Tap Mounting hole size: Figure A = ⅜"

Outline Dimensions

Technical Notes

1. Hi-pot tested at 1,500 VRMS.

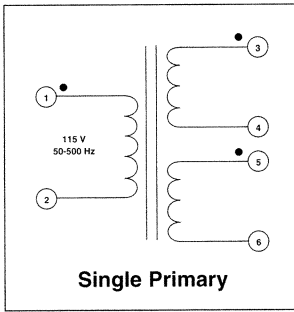

Figure A

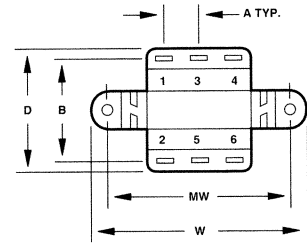
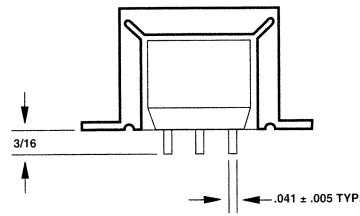

Figure B

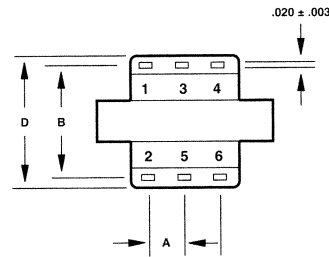
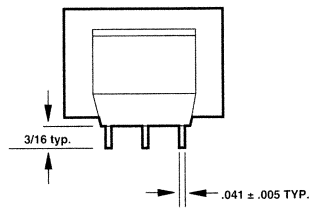

Figure C

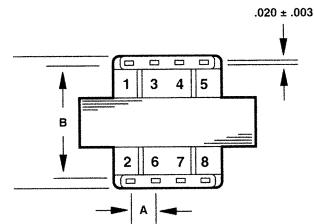
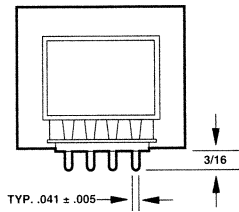

Figure D

